

Article number: 4395000241

Description: Rota-fix shaft-hub connection F24x55
Stainless steel

Measures

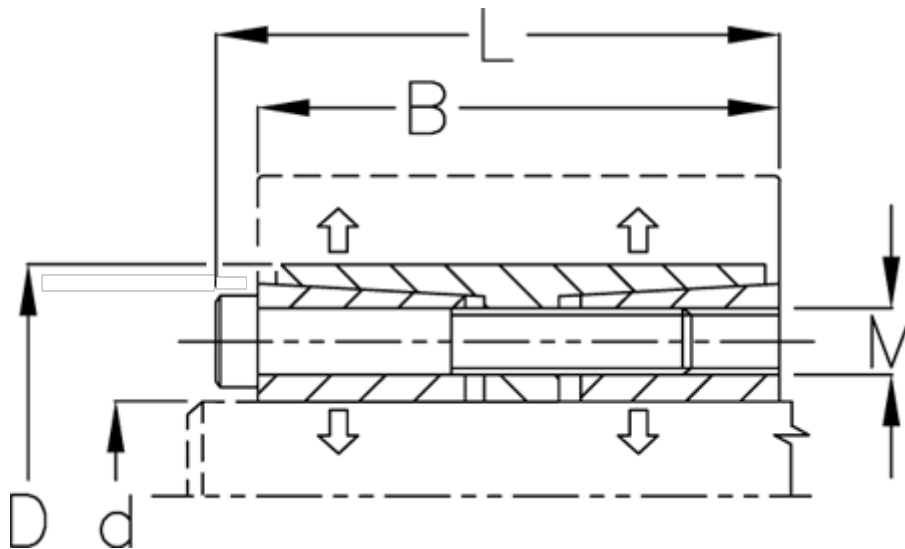

B mm	= 40
d H8 mm	= 24
D mm	= 55
Fit tolerance	= Aksel h8, Nav H8
F kN torque	= 35.4
L mm	= 46
M mm	= M6
P N/mm ² surface pressure on shaft/hub	= 34

Surface roughness	= R? ? 3.2 μm
T N m torque	= 420
Ts N m bolt tightening torque	= 11.8